

CLAMPING - SERRAGE - **SERRAGGIO**

GENERIC AND CONSUMABLE TOOLS - OUTILS GÉNÉRIQUES ET CONSOMMABLES - **UTENSILERIA GENERICA e CONSUMABILI**

HYDRAULIC - HYDRAULIQUE - **IDRAULICA**

JOINERY - MENUISERIE - **FALEGNAMERIA**

CARRIAGE - CARROSSERIE - **CARROZZERIA**

PULLERS - EXTRACTEURS - **ESTRATTORI**

WRENCHES AND SOCKETS - CLÈS ET DOUILLES - CHIAVI e BUSSOLE

PLIERS AND CUTTING - PINCES ET COUPANTES - **PINZE - TENAGLIE e FORBICI**

SCREWDRIVERS - TOURNEVIS - **GIRAVITI**

CUT AND DRILLING - COUPER ET PERCER - **TAGLIARE e FORARE**

MAINTENANCE - ENTRETIEN - **MANUTENZIONI VARIE**

MEASURING - MESURER - **MISURARE e TRACCIARE**

BUILDING - BATIMENT - **EDILIZIA**

HAMMERS AND MALLETS - MARTEAUX ET MAILLETS - **MARTELLI E MAZZUOLE**

BOX - BAGS - TROUSSE - COFFRES - SACS - TROUSSE - **CASSETTE - BORSE - TROUSSE e COMPONENTI**

ELECTRICITY - ELECTRICITE - **ELETTRICO**

ALFA CENTURY

CHIAVI A "T" ESAGONALI
SOCKET WRENCH WITH "T" HANDLE
CLÉS A BEQUILLE A SIX PANS

Art. 370

- TIPO FISSA - acciaio al cromo-vanadio - cromata - impugnatura scorrevole - testa lucida
- FIXED pattern - chrome-vanadium steel - chromed - sliding handle - polished head
- Modele SIMPLE - acier au chrome-vanadium - chromée - broche coulissante - tête polie



CODICE	EAN	Ø	g	cm
37002	8028108370025	6	120	1
37003	8028108370032	7	120	1
37004	8028108370049	8	175	1
37005	8028108370056	9	175	1
37006	8028108370063	10	240	1
37007	8028108370070	11	240	1
37008	8028108370087	12	240	1
37009	8028108370094	13	370	1
37010	8028108370100	14	350	1
37011	8028108370117	15	450	1
37012	8028108370124	16	415	1
37013	8028108370131	17	480	1
37014	8028108370148	18	525	1
37015	8028108370155	19	610	1
37018	8028108370186	22	820	1
37020	8028108370209	24	970	1

Art. 374

- TIPO SNODATO - cromata - lunghezza mm. 500
- SWIVELING SOCKET pattern - chromed - length mm. 500
- Modele ARTICULEE - chromée - longueur mm. 500



CODICE	EAN	Ø	g	cm
37402	8028108374023	6	250	1
37403	8028108374030	7	250	1
37404	8028108374047	8	265	1
37405	8028108374054	9	265	1
37406	8028108374061	10	450	1
37407	8028108374078	11	450	1
37408	8028108374085	12	450	1
37409	8028108374092	13	460	1
37410	8028108374108	14	465	1
37411	8028108374115	15	685	1
37412	8028108374122	16	630	1
37413	8028108374139	17	690	1
37414	8028108374146	18	690	1
37415	8028108374153	19	730	1
37416	8028108374160	20	960	1
37417	8028108374177	21	960	1
37418	8028108374184	22	1040	1
37420	8028108374207	24	1040	1

Art. 376

- TIPO SNODATO ESAGONO MASCHIO - cromata - lunghezza mm 500
- SWIVELING SOCKET pattern - HEX MALE chromed - length mm 500
- Modele ARTICOULE SIX MALE - chromée - longueur mm 500



CODICE	EAN	Ø	g	cm
37602	8028108376027	3	265	1
37603	8028108376034	4	265	1
37604	8028108376041	5	320	1
37605	8028108376058	6	410	1
37606	8028108376065	8	460	1

Art. 378

- TIPO LILLIPUT nichelate
- LILLIPUT pattern nickeled
- Modele LILLIPUT nickelée

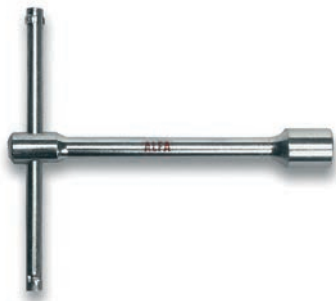

CODICE	EAN			
37803	8028108378038	5	25	1
37804	8028108378045	6	35	1
37805	8028108378052	7	44	1
37806	8028108378069	8	48	1
37808	8028108378083	10	117	1
37810	8028108378106	12	155	1
37811	8028108378113	13	203	1

CHIAVI DI MANOVRA E BUSSOLE WRENCHES AND SOCKET WRENCHES CLES ET CLES A DOUILLE

Art. 382

- TIPO A CROCE - per dadi ruote - bocche esagonali cromata
- FOUR WAY RIM pattern - six points - chromed
- Modele A CROIX - six pans - chromée



CODICE	EAN		L		
38201	8028108382011	17x19x22 13/16"	395	1200	1

Art. 383

- TIPO A CROCE per dadi ruote - bocche esagonali cromata
- FOUR WAY RIM pattern six points - chromed
- Modele A CROIX six pans - chromée



CODICE	EAN		L		
38301	8028108383018	17x19x21 quadro 1/2"	395	1100	1

Art. 386

- TIPO A FORCHETTA DOPPIA - acciaio cromo-vanadio - cromata
- DOUBLE ENDED OPEN JAW pattern - chrome-vanadium steel - chromed
- Modele A FOURCHE DOUBLES - acier chrome-vanadium - chromée



UNI 6736 - DIN 3110

CODICE	EAN		L		
38602	8028108386026	6x7	120	20	12
38603	8028108386033	8x9	135	30	12
38604	8028108386040	10x11	150	50	12
38605	8028108386057	12x13	165	70	12
38606	8028108386064	14x15	180	95	12
38607	8028108386071	16x17	195	125	12
38608	8028108386088	18x19	210	160	12
38609	8028108386095	20x22	225	195	12
38610	8028108386101	21x23	240	220	6
38611	8028108386118	24x26	260	300	6
38612	8028108386125	25x28	280	350	6
38613	8028108386132	30x32	300	450	6

Art. 386/A

- SERIE DI 8 CHIAVI A FORCHETTA DOPPIA - in scatola di cartone
- SET OF 8 DOUBLE ENDED OPEN JAW WRENCHES - in carton box
- JEU DE 8 CLES A FOURCHE DOUBLES - dans une boîte en carton



CODICE	EAN			
38661	8028108386613	6x7-8x9-10x11-12x13 14x15-16x17-18x19-20x22	780	1

Art. 386/B

- SERIE DI 12 CHIAVI A FORCHETTA DOPPIA - in scatola di cartone
- SET OF 12 DOUBLE ENDED OPEN JAW WRENCHES - in carton box
- JEU DE 12 CLES A FOURCHE DOUBLES - dans une boîte en carton



CODICE	EAN			
38671	8028108386712	6x7-8x9-10x11-12x13 14x15-16x17-18x19-20x22 21x23-24x26-25x28-30x32	2125	1

Art. 386/C

- SERIE DI 12 CHIAVI A FORCHETTA DOPPIA - su supporto in metallo appendibile
- SET OF 12 DOUBLE ENDED OPEN JAW WRENCHES - hanging metal bearing
- JEU DE 12 CLES A FOURCHE DOUBLES - sur un support en metal



UNI 6736 - DIN 3110

CODICE	EAN			
38681	8028108386811	6x7-8x9-10x11-12x13 14x15-16x17-18x19-20x22 21x23-24x26-25x28-30x32	2800	1

Art. 387

- TIPO POLIGONALE DOPPIA CURVA - acciaio cromo-vanadio - cromata
- DOUBLE ENDED RING pattern - chrome-vanadium steel - chromed
- Modele POLYGONALE DOUBLE CONTRE-COUDEE - acier au chrome-vanadium - chromée



UNI 6740 - DIN 838

CODICE	EAN		L		
38702	8028108387023	6X7	165	45	12
38703	8028108387030	8X9	180	65	12
38704	8028108387047	10X11	190	85	12
38705	8028108387054	12X13	210	110	12
38706	8028108387061	14X15	225	145	12
38707	8028108387078	16X17	245	190	6
38708	8028108387085	18X19	265	250	6
38709	8028108387092	20X22	290	340	6
38710	8028108387108	21X23	305	380	6
38711	8028108387115	24X26	325	480	6
38712	8028108387122	25X28	335	550	6
38713	8028108387139	30X32	360	725	6

Art. 387/A

- SERIE DI 8 CHIAVI POLIGONALI DOPPIE CURVE - in scatola di cartone
- SET OF 8 DOUBLE ENDED RING WRENCHES - in carton box
- JEU DE 8 CLES POLYGONALES DOUBLES CONTRE-COUDEES - dans une boîte en carton

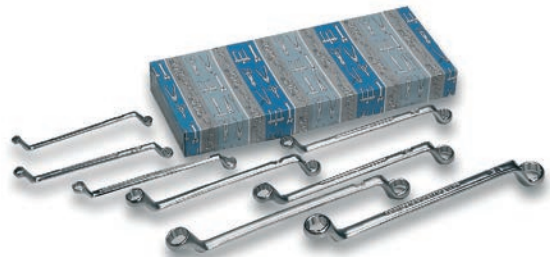

CODICE	EAN			
38761	8028108387610	6x7-8x9-10x11-12x13 14x15-16x17-18x19-20x22	1310	1

Art. 387/B

- SERIE DI 12 CHIAVI POLIGONALI DOPPIE CURVE - in scatola di cartone
- SET OF 12 DOUBLE ENDED RING WRENCHES - in carton box
- JEU DE 12 CLES POLYGALES DOUBLES CONTRE-COUEDES - dans une boîte en carton



CODICE	EAN			
38771	8028108387719	6x7-8x9-10x11-12x13 14x15-16x17-18x19-20x22 21x23-24x27-25x28-30x32	3210	1

Art. 388

- TIPO COMBINATA A FORCHETTA E POLIGONALE PIEGATA acciaio cromo-vanadio - cromata
- COMBINATION pattern - chrome-vanadium steel - chromed
- Modele MIXTE A FOURCHE ET POLYGONALE - acier au chrome-vanadium - chromée



UNI 6741 - DIN 3113

CODICE	EAN		L		
38802	8028108388020	6	105	15	12
38803	8028108388037	7	110	19	12
38804	8028108388044	8	120	25	12
38805	8028108388051	9	125	30	12
38806	8028108388068	10	135	40	12
38807	8028108388075	11	145	45	12
38808	8028108388082	12	155	58	12
38809	802810838809-1	13	165	75	12
38810	8028108388105	14	175	85	12
38811	8028108388112	15	185	100	12
38812	8028108388129	16	185	100	12
38813	8028108388136	17	205	125	12
38814	8028108388143	18	205	125	12
38815	8028108388150	19	230	160	12
38816	8028108388167	20	230	160	12
38817	8028108388174	21	250	195	12
38818	8028108388181	22	250	195	12
38819	8028108388198	23	270	275	6
38820	8028108388204	24	270	275	6
38821	8028108388211	25	290	350	6
38822	8028108388228	26	290	350	6
38823	8028108388235	27	310	420	6
38824	8028108388242	28	310	420	6
38825	8028108388259	29	330	495	6
38826	8028108388266	30	330	495	6
38827	8028108388273	32	350	575	6

Art. 388/A

- SERIE DI 8 CHIAVI COMBINATE A FORCHETTA E POLIGONALE PIEGATA in scatola di cartone
- SET OF 8 COMBINATION WRENCHES - in carton box
- JEU DE 8 CLES MIXTES A FOURCHE ET POLYGONALE CONTRE-COUEDE dans une boîte en carton



CODICE	EAN			
38861	8028108388617	7-8-10-11-13-17-19-22	760	1

Art. 388/B

- SERIE DI 17 CHIAVI COMBINATE A FORCHETTA E POLIGONALE PIEGATA in scatola di cartone
- SET OF 17 COMBINATION WRENCHES - in carton box
- JEU DE 17 CLES MIXTES A FOURCHE ET POLYGONALE CONTRE-COUEDE dans une boîte en carton



CODICE	EAN			
38871	8028108388716	6-7-8-9-10-11-12-13-14 15-16-17-18-19-20-21-22	1630	1

Art. 388/C

- SERIE DI 26 CHIAVI COMBINATE A FORCHETTA E POLIGONALE PIEGATA in scatola di cartone
- SET OF 26 COMBINATION WRENCHES - in carton box
- JEU DE 26 CLES MIXTES A FOURCHE ET POLYGONALE CONTRE-COUEDE dans une boîte en carton



CODICE	EAN			
38881	8028108388815	6-7-8-9-10-11-12-13-14 15-16-17-18-19-20-21-22 23-24-25-26-27-28-29-30-32	5010	1

Art. 389

- SERIE DI 13 CHIAVI COMBinate A FORCHETTA E POLIGONALE PIEGATA su supporto in metallo appendibile
- SET OF 13 COMBINATION WRENCHES - Hanging metal bearing
- JEU DE 13 CLES MIXTES A FOURCHE ET POLYGONALE CONTRE-COUEE sur un support en metal



Art. 389/A

- SERIE DI 26 CHIAVI COMBinate A FORCHETTA E POLIGONALE PIEGATA su supporto in metallo appendibile
- SET OF 26 COMBINATION WRENCHES - Hanging metal bearing
- JEU DE 26 CLES MIXTES A FOURCHE ET POLYGONALE CONTRE-COUEE sur un support en metal

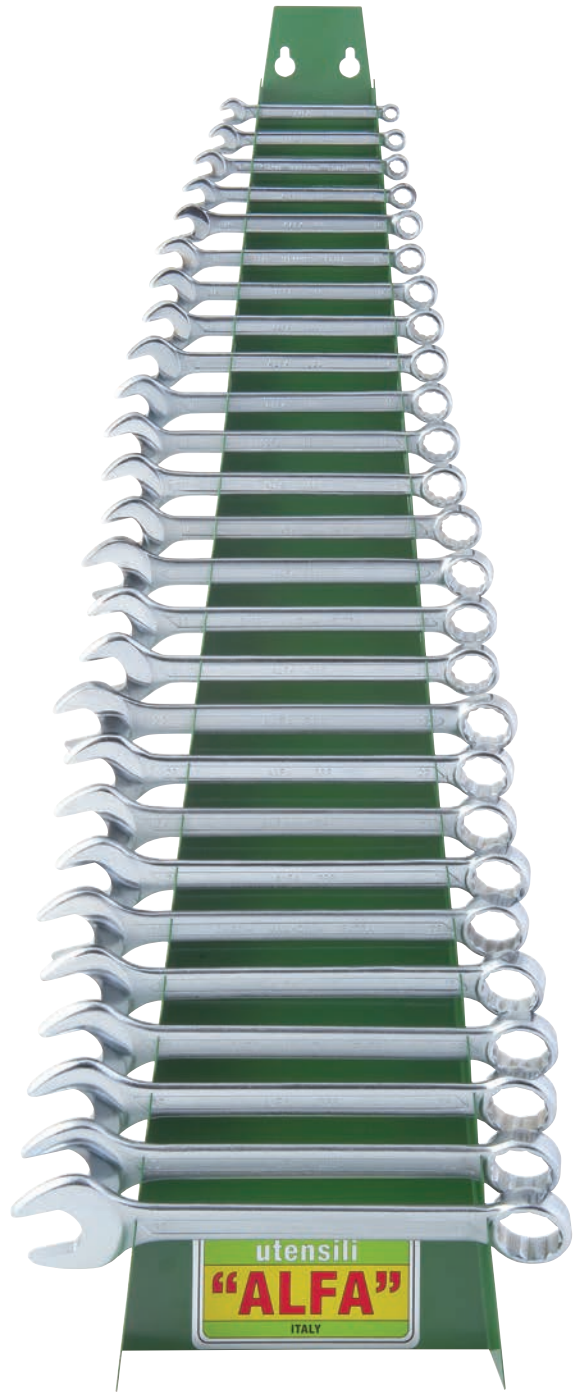

CODICE	EAN			
38901	8028108389010	9-10-12-13-14-15-16 17-18-19-20-21-22	2100	1

CODICE	EAN			
38961	8028108389614	6-7-8-9-10-11-12-13-14 15-16-17-18-19-20-21-22 23-24-25-26-27-28-29-30-32	6000	1

Art. 390

- TIPO POLIGONALE DOPPIA CURVA PER PONTEGGI - nichelata
- DOUBLE ENDED RING FOR SCAFFOLD - pattern nickleed
- Modele CLE POLYGONALE DOUBLE CONTRE-COUDEE POUR ECHAFAUDAGE nickelée



CODICE	EAN		L		
39001	8028108390016	21x22	316	620	1

Art. 391

- CHIAVE FISSA AD UNA BOCCA - DIN 894 - in acciaio al carbonio - brunita
- SINGLE OPEN END SPANNER - DIN 894 - carbon steel - black finished
- Modele A FOURCHE - DIN 895 - acier au carbone - brunie



CODICE	EAN		L		
39102	8028108391020	6	73	10	1
39103	8028108391037	7	78	10	1
39104	8028108391044	8	94	18	1
39105	8028108391051	9	100	20	1
39106	8028108391068	10	104	23	1
39107	8028108391075	11	112	40	1
39108	8028108391082	12	123	40	1
39109	8028108391099	13	132	45	1
39110	8028108391105	14	140	45	1
39111	8028108391112	15	145	65	1
39112	8028108391129	16	150	70	1
39113	8028108391136	17	157	70	1
39114	8028108391143	18	160	95	1
39115	8028108391150	19	170	100	1
39116	8028108391167	21	180	130	1
39117	8028108391174	22	195	150	1
39118	8028108391181	23	205	165	1
39119	8028108391198	24	215	180	1
39120	8028108391204	25	225	210	1
39121	8028108391211	27	235	235	1
39122	8028108391228	30	265	315	1
39123	8028108391235	32	275	340	1
39124	8028108391242	34	285	340	1
39125	8028108391259	36	295	455	1
39126	8028108391266	38	301	540	1
39127	8028108391273	41	340	580	1
39128	8028108391280	46	375	750	1
39129	8028108391297	50	402	950	1
39130	8028108391303	55	443	1160	1
39131	8028108391310	60	475	1625	1
39132	8028108391327	65	515	1705	1
39133	8028108391334	70	560	2500	1
39134	8028108391341	75	600	3500	1
39135	8028108391358	80	670	3500	1
39136	8028108391365	85	680	4780	1
39137	8028108391372	90	680	5450	1
39138	8028108391389	100	847	7800	1
39139	8028108391396	105	1000	8000	1

Art. 391/A

- CHIAVE FISSA A DUE BOCCHE - DIN 895 - in acciaio al carbonio - brunita
- DOUBLE OPEN END SPANNER - DIN 895 - carbon steel - black finished
- Modele A FOURCHE DOUBLES - DIN 895 - acier au carbone - brunie



CODICE	EAN		L		
39142	8028108391426	6x7	95	15	1
39143	8028108391433	7x8	105	18	1
39144	8028108391440	8x9	105	20	1
39145	8028108391457	8x10	115	26	1
39146	8028108391464	10x11	120	27	1
39147	8028108391471	10x13	120	34	1
39148	8028108391488	12x13	140	46	1
39149	8028108391495	14x15	150	53	1
39150	8028108391501	13x17	160	64	1
39151	8028108391518	17x19	170	92	1
39152	8028108391525	17x22	190	127	1
39153	8028108391532	19x22	190	126	1
39154	8028108391549	19x24	215	166	1
39155	8028108391556	20x22	190	134	1
39156	8028108391563	22x24	215	163	1
39157	8028108391570	24x27	240	230	1
39158	8028108391587	24x30	264	268	1
39159	8028108391594	27x30	270	322	1
39160	8028108391600	30x32	270	385	1
39161	8028108391617	36x41	345	700	1

Art. 392

- ASSORTIMENTO IN SERIE DI 19 PEZZI DA 1/4" - 13 chiavi a bussola - bocca surface - scatola metallica
- SET OF 19 PIECES 1/4" - 13 sockets - surface drive - metal box
- ASSORTIMENT DE 19 PIECES 1/4" - 13 douilles - surface pans - boîte métallique





CODICE	EAN	Descrizione	Misura		
39201	8028108392010	bussola	4-4,5-5-5,5 6-7-8-9-10 11-12-13-14	1062	1
		cricchetto			
		prolunga	2"-6"		
		snodo			
		leva a T			
		avvitatore			

Art. 394

- ASSORTIMENTO IN SERIE DI 24 PEZZI DA 3/8" - 17 chiavi a bussola - bocca surface - scatola metallica
- SET OF 24 PIECES 3/8" 17 sockets - surface drive - metal box
- ASSORTIMENT DE 24 PIECES 3/8" 17 douilles - surface pans - boite metallique





CODICE	EAN	Descrizione	Misura		
39401	8028108394014	bussola	6-7-8-9-10 11-12-13-14 15-16-17-18 19-20-21-22	2830	1
		cricchetto			
		prolunga	3"-6"		
		snodo			
		leva a T			
		bussola per candela	16-20,6		

Art. 396

- TIPO A BUSSOLA DA 1/2" - bocca esagonale - acciaio al cromo-vanadio - cromata
- SOCKET pattern 1/2" - hexagonal - chrome-vanadium steel chromed
- Modele A DOUILLE DE 1/2" - à six pans - en acier au chrome vanadium chromée





CODICE	EAN	L			
39602	8028108396025	38	8	44	6
39603	8028108396032	38	9	44	6
39604	8028108396049	38	10	46	6
39605	8028108396056	38	11	46	6
39606	8028108396063	38	12	48	6
39607	8028108396070	38	13	50	6
39608	8028108396087	38	14	52	6
39609	8028108396094	38	15	56	6
39610	8028108396100	38	16	56	6
39611	8028108396117	38	17	72	6
39612	8028108396124	38	18	72	6
39613	8028108396131	38	19	72	6
39614	8028108396148	38	20	76	6
39615	8028108396155	38	21	82	6
39616	8028108396162	38	22	86	6
39617	8028108396179	40	23	100	1
39618	8028108396186	40	24	112	1
39619	8028108396193	43	26	138	1
39620	8028108396209	43	27	168	1
39621	8028108396216	45	28	178	1
39622	8028108396223	45	30	206	1
39623	8028108396230	45	32	230	1

Art. 397

- TIPO A BUSSOLA DA 1/2" - bocca surface - acciaio al cromo-vanadio - cromata
- SOCKET pattern 1/2" - surface drive - chrome-vanadium steel chromed
- Modele A DOUILLE DE 1/2" - à six pans surface - en acier au chrome vanadium - chromée



CODICE	EAN	L			
39702	8028108397022	38	8	44	6
39703	8028108397039	38	9	44	6
39704	8028108397046	38	10	46	6
39705	8028108397053	38	11	46	6
39706	8028108397060	38	12	48	6
39707	8028108397077	38	13	50	6
39708	8028108397084	38	14	52	6
39709	8028108397091	38	15	56	6
39710	8028108397107	38	16	56	6
39711	8028108397114	38	17	72	6
39712	8028108397121	38	18	72	6
39713	8028108397138	38	19	72	6
39714	8028108397145	38	20	76	6
39715	8028108397152	38	21	82	6
39716	8028108397169	38	22	86	6
39717	8028108397176	40	23	100	1
39718	8028108397183	40	24	112	1
39719	8028108397190	43	26	138	1
39720	8028108397206	43	27	168	1
39721	8028108397213	45	28	178	1
39722	8028108397220	45	30	206	1
39723	8028108397237	45	32	230	1

Art. 399

- CRICCHETTO REVERSIBILE 72 DENTI - per bussole da 1/2" - acciaio cromo-vanadio - cromato - impugnatura in plastica
- RATCHET HANDLE 72 TEETH - for sockets 1/2" - chrome-vanadium steel - chromed - plastic handle
- CLIQUET REVERSIBLE 72 DENTS - pour douilles de 1/2" en acier au chrome-vanadium - chromée - poigné en plastique



CODICE	EAN	L			
39901	8028108399019	245	1/2"	480	1

Art. 400

- LEVA A T - quadro scorrevole - acciaio al cromo-vanadio - cromata
- SLIDING T HANDLE - with connection - chrome-vanadium steel - chromed
- POIGNEE A BEQUILLE - avec carré mâle coulissant - en acier au chrome-vanadium - chromée



CODICE	EAN	L			
40001	8028108400012	250	1/2"	374	6

Art. 401

- PROLUNGA - in acciaio al cromo-vanadio - cromata
- LOCKING EXTENSION - chrome-vanadium steel - chromed
- RALLONGE - en acier au chrome-vanadium - chromée



CODICE	EAN	L			
40101	8028108401019	150	1/2"	318	6

Art. 401/A

- PROLUNGA - in acciaio al cromo-vanadio - cromata
- LOCKING EXTENSION - chrome-vanadium steel - chromed
- RALLONGE - en acier au chrome-vanadium - chromée



CODICE	EAN	L			
40161	8028108401613	250	1/2"	478	6

Art. 402

- SNODO UNIVERSALE - in acciaio al cromo-vanadio - cromato
- UNIVERSAL JOINT - chrome-vanadium steel - chromed
- CARDAN UNIVERSEL - en acier au chrome-vanadium - chromée



CODICE	EAN	L			
40201	8028108402016	70	1/2"	140	6

Art. 403

- ASSORTIMENTO IN SERIE DI 15 PEZZI DA 1/2" - 12 chiavi a bussola - bocca esagonale - scatola metallica
- SET OF 15 PIECES 1/2" - 12 sockets - hexagon - metal box
- ASSORTIMENT DE 15 PIECES 1/2" - 12 douilles - six pans - boite metallique



CODICE	EAN	Descrizione	Misura		
40301	8028108403013	396	10-11-12-13 14-15-16-17 18-19-20-22	2700	1
		398	255		
		400	250		
		401/A	250		

Art. 403/S

- ASSORTIMENTO IN SERIE DI 15 PEZZI DA 1/2" - 12 chiavi a bussola - bocca surface - scatola metallica
- SET OF 15 PIECES 1/2" - 12 sockets - surface drive - metal box
- ASSORTIMENT DE 15 PIECES 1/2" - 12 douilles - surface pans - boite metallique



CODICE	EAN	Descrizione	Misura		
40391	8028108403914	397	10-11-12-13 14-15-16-17 18-19-20-22	2700	1
		398	255		
		400	250		
		401/A	250		

Art. 404

- ASSORTIMENTO IN SERIE DI 24 PEZZI DA 1/2" - 18 chiavi a bussola - bocca esagonale - scatola metallica
- SET OF 24 PIECES 1/2" - 18 sockets - hexagon - metal box
- ASSORTIMENT DE 24 PIECES 1/2" - 18 douilles - six pans - boite metallique



CODICE	EAN	Descrizione	Misura		
40401	8028108404010	396	12-13-14-15 16-17-18-19-20 21-22-23-24-26 27-28-30-32	5900	1
		398	255		
		400	250		
		401	125		
		401/A	250		
		402	70		
		manovella	405		

Art. 404/S

- ASSORTIMENTO IN SERIE DI 24 PEZZI DA 1/2" - 18 chiavi a bussola - bocca surface - scatola metallica
- SET OF 24 PIECES 1/2" - 18 sockets - surface drive - metal box
- ASSORTIMENT DE 24 PIECES 1/2" - 18 douilles - surface pans - boite metallique



CODICE	EAN	Descrizione	Misura		
40491	8028108404911	396	12-13-14-15 16-17-18-19-20 21-22-23-24-26 27-28-30-32	5900	1
		398	255		
		400	250		
		401	125		
		401/A	250		
		402	70		
		manovella	405		

CHIAVI A SETTORE SQUARE HOOK WRENCHES CLÉS A ERGOTS

Art. 405

- TIPO A NASELLO QUADRO - acciaio al cromo - DIN 1810 - cromata
- SQUARE NOSE pattern - chrome steel - DIN 1810 - chromed
- Modele A NEZ CARREE - acier au chrome - Din 1810 - chromée



CODICE	EAN	Misura	Ø Ghiera		
40502	8028108405024	25/28	136	50	1
40503	8028108405031	30/32	136	50	1
40504	8028108405048	34/36/38	170	95	1
40505	8028108405055	40/42	170	95	1
40506	8028108405062	45/50	205	150	1
40507	8028108405079	52/55	205	150	1
40508	8028108405086	58/62/65	240	220	1
40509	8028108405093	68/75	240	220	1
40510	8028108405109	80/85/90	280	370	1
40511	8028108405116	92/95	280	370	1
40512	8028108405123	98/100	280	370	1
40513	8028108405130	110/115	320	740	1
40514	8028108405147	120/130	330	740	1
40515	8028108405154	135/145	380	1100	1
40516	8028108405161	155/165	380	1120	1
40517	8028108405178	180/195	380	1140	1

Art. 405/A

- TIPO A NASELLO TONDO - acciaio al cromo - DIN 1810 - cromata
- ROUND NOSE pattern - chrome steel - DIN 1810 - chromed
- Modele A NEZ RONDE - acier au chrome - DIN 1810 - chromée



CODICE	EAN	Misura	Ø Ghiera		
40562	8028108405628	25/28	136	50	1
40563	8028108405635	30/32	136	50	1
40564	8028108405642	34/36	170	95	1
40565	8028108405659	40/42	170	95	1
40566	8028108405666	45/50	205	150	1
40567	8028108405673	52/55	205	150	1
40568	8028108405680	58/62	240	220	1
40569	8028108405697	68/75	240	220	1
40570	8028108405703	80/90	280	370	1
40571	8028108405710	95/100	280	370	1
40572	8028108405727	110/115	320	740	1
40573	8028108405734	120/130	330	740	1
40574	8028108405741	135/145	380	1100	1
40575	8028108405758	155/165	380	1120	1
40576	8028108405765	180/195	380	1140	1